

The Magic in 2-Channel Sound Reproduction - Why is it so Rarely Heard?

Siegfried Linkwitz*

Linkwitz Lab, Corte Madera, California, USA

Abstract: Hearing, finding the direction, distance and significance of a source of sound in various acoustic environments, is a survival mechanism in the evolution of living organisms. Hearing two strongly correlated sources of sound, either from earphones or two loudspeakers, is an unnatural phenomenon, from which the ear-brain apparatus is asked to draw an illusion of reality. Misleading cues must be eliminated from the sound presentation for the illusion to happen convincingly. In the case of earphone presentation, which typically suffers from a high degree of distance distortion, i.e. distance foreshortening, the ear signals must change with head movement to externalize the illusion. In the case of loudspeaker presentation there is already the distance between listener and speakers, which typically is perceived as the minimum distance to the illusionary aural scene or phantom scene. But that scene is usually hard bounded by the speakers, which are recognized as such by the ear-brain perceptual apparatus. One or the other speaker is preferred as the source, when the listener moves a short distance away laterally from the "sweet spot". In a reverberant room, where the listener not only hears the direct sound but also the reflected sound, i.e. the off-axis radiated sound, the ear-brain perceptual apparatus must be allowed to withdraw attention from room and speakers and focus attention upon the direct sound to create a convincing illusion of the reproduced acoustic event. For this to happen misleading perceptual cues must be eliminated. The speakers must be placed so that reflections are delayed relative to the direct sound. The speakers must be free from spurious resonant radiation and their off-axis radiation must follow their on-axis frequency response for the reverberant sound to be neutral. The polar radiation pattern must be essentially either omni-directional, cardioid or dipolar, aiming for constant directivity. The speakers must be acoustically small, yet capable of realistic volume levels at low non-linear distortion. Two prototype speakers and the evolution of their radiation pattern design will be discussed: a full-range, acoustically small dipole and a hybrid, omni-cardioid-dipole design. Either speaker is capable of disappearing from perception and rendering an aural scene in a reverberant room that is like a magic act.

Keywords: Sound reproduction, loudspeaker, room, perception, magic, aural scene, radiation pattern, constant directivity, LX521, LXmini.

1. INTRODUCTION

It may be claimed that few stereo listeners, audiophiles, or audio professionals have heard what stereo is truly capable of because loudspeakers for domestic use are generally not designed with a reverberant playback space in mind. Furthermore, phantom sources, which are key elements of stereo reproduction, are unnatural phenomena. Humans are programmed by evolution to detect direction and distance of real sources of sound in a multitude of reverberant environments. Stereo sound reproduction in a reverberant room must therefore be treated like the creation of a magic trick for the ears - a trick in which the listener withdraws attention from the loudspeakers and the room. What remains to enjoy is a phantom auditory scene.

The room, the loudspeakers, and the recording participate in the creation of the illusion. Most important are the loudspeaker's radiation pattern and the placement of the speakers in the room. And though the room is often blamed for resulting poor stereo performance, it is the loudspeaker's radiation pattern,

which determines how the room is illuminated with sound and thus how the room talks back to the listener and interferes perceptually with the direct sound from the loudspeakers.

1.1. Hearing

Hearing has evolved as an effective survival mechanism for detecting direction, distance, and meaning of a source of sound in an environment where there may be multiple sources of sound and reflections [1]. Hearing still operates like that today when the head automatically turns towards a surprising or unfamiliar sound to figure out what is causing the sound and how far away it is. Having identified the source and its proximity the response is either to run, watch out, ignore it or be annoyed.

The brain carries a vast catalog of familiar sounds. Voices of different individuals are recognized almost immediately even over a phone connection of poor quality. The sound of a human voice or a musical instrument coming from somewhere is usually recognized as originating from a loudspeaker or a real person or instrument. Why is that? Every loudspeaker has a sonic signature, a radiation pattern, and a power response which defines how it interacts with the space around it [2]. A person's voice has a sonic signature

*Address correspondence to this author at the Linkwitz Lab, Corte Madera, California, USA; Tel: +1-415-924-0241; E-mail: slinkwitz@gmail.com

and, unless a loudspeaker is build to mimic that signature, it is easy to distinguish a live person from a loudspeaker reproduction, especially in a reverberant environment. Musical instruments, of course, also have their sonic signature be it a violin, cello, clarinet, flute, piano, etc. [3]. Since it is impossible to build a loudspeaker that can assume all those signatures, the optimum solution will be a loudspeaker which does not add its own signature to the reproduction of a recording, i.e. a loudspeaker with a neutral signature when radiating into 4π reverberant space.

1.2. Anechoic Stereo Reproduction

It is instructive to first look at stereo reproduction under anechoic conditions; hearing under those conditions is not a natural experience, but it shows how the ear/brain apparatus copes with such situations. Both headphones and loudspeakers will be considered.

1.2.1. Headphone Stereo

Headphones render sound under almost anechoic conditions. The cavities between eardrum and headphone diaphragm, whether from circum-aural, supra-aural or intra-aural phones, often color the sound. Most importantly, perceived distances to the auditory scene are foreshortened, which is an unnatural phenomenon. It is easy to make binaural recordings where a person whispers into the listener's ears, but all sources of sound are closer than they were in reality. Typically, sounds in the frontal direction are perceived as originating inside the listener's head. Much engineering effort is spent these days on embedding Head Related Transfer Functions into the signal transmission path in order to present sound sources in 3D-space. But HRTFs are highly individualistic. Thus the results of such efforts are very limited unless the HRTFs are made to change and track head movement, Figure 1.

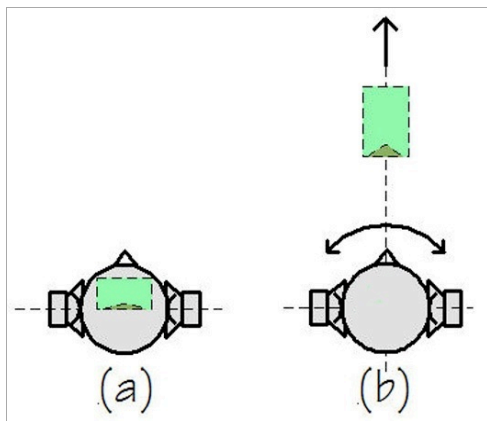

Figure 1: Headphone stereo. Localization of the auditory scene inside the head (a), or outside the head (b) when the HRTF of the ear signals tracks with head movement.

With head tracking, sound sources can be placed at any distance from and around the listener. The author is convinced from personal experience that the change in HRTF with head movement is much more important than the individualized correctness of the HRTF. A headphone system with head tracking is clearly capable of the magic referred to above as long as one can be comfortable with transducers occluding the ears and placing the listener into a virtual reality space.

1.2.2. Loudspeaker Stereo

Anechoic, reflection free spaces are essential for loudspeaker measurement and design; they are also essential to studying directional hearing effects. For instance, two identical loudspeakers and a listener are set up in equilateral triangle fashion in an anechoic chamber, Figure 2. Identical signals are fed to each loudspeaker. If the listener's head had been blocked - i.e. not allowed to move - and there were no visual cues as to the loudspeaker location, then the listener hears a phantom source inside his head between the ears (a), just as with headphones.

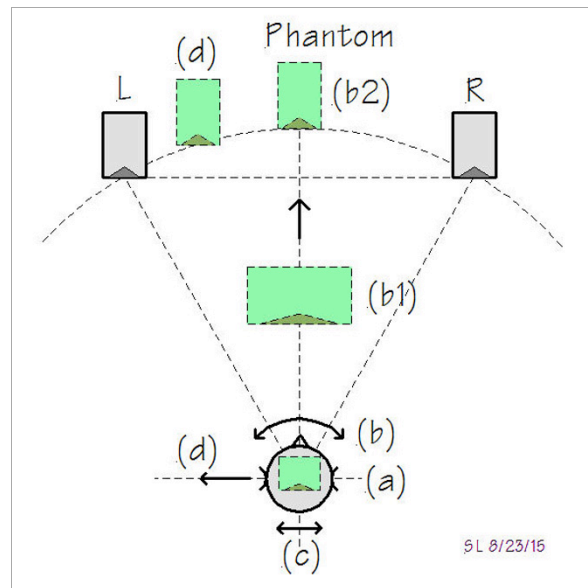

Figure 2: Loudspeaker stereo under anechoic conditions. Phantom inside clamped head (a). Externalized phantom with head turning (b1, b2). Tonality changes (combing) with small lateral shifts (c). Large lateral head shifts and jumping of phantom to the nearest speaker (d).

If the listener is allowed to turn his head, he then perceives the phantom source in front of him (b2) at approximately the distance to the invisible loudspeakers. For highly directive speakers the center phantom may actually appear in front of the speakers (b1). If the source signal is noise and the listener moves a small distance laterally, then a change in

tonality is heard due to changing interference (combing) of left and right loudspeaker signals at each ear (c). For greater lateral shifts (d) the signal collapses into the nearest loudspeaker and head turning confirms the location of the physical source of sound.

In the recording/mixing process, monaural sources are level panned to locations between the speakers and amplitude and phase differences between the outputs from one or more directional microphone pairs are used to render an acoustic scene between loudspeakers [4, 5, 6]. An off-center phantom source, such as in Figure 2 (d) for a centered listener at (a), can be created by a larger amplitude signal from the left than the right loudspeaker. Below 800 Hz the superimposed loudspeaker signals at left and right ears are converted into timing differences (ITD) between the ears as if they were generated from a real source at location (d), [7, 8, 9, 10]. Higher frequency content above 2kHz with larger amplitude from left than right loudspeaker mimics the head shading (IID) effect and stabilizes the off-center phantom. But transient signals can quickly lead to identification of left or right speaker as the real source. It is a task for the mixing engineer to distribute a phantom scene between the loudspeakers. An acoustically dead room is generally preferred as work environment because it allows the mixing engineer to hear more clearly while making decisions. But it is an artificial environment.

2. ROOM RESPONSE

The room contributes to the listening experience *via* three phenomena, which are caused by sound from the loudspeakers being reflected, diffused and absorbed by the room's surfaces and objects in it and arriving at the listener's ears together with the direct signals from the loudspeakers.

1. Standing waves, modes or room resonances at low frequencies below the Schroeder frequency,
2. The reverberated sound field as the result of multiple, overlapping room resonances, diffusion and absorption of sound above the Schroeder frequency,
3. Discrete reflections of the loudspeaker signals, particularly above 1kHz.

2.1. Room Reflections

While anechoic conditions are useful for studying directional hearing, one must be careful to translate the

findings directly to situations where multiple reflections of a signal occur. Again, this is a situation that is predominant in natural hearing and where evolution has optimized the signal processing between the ears for survival purposes. For example, it is important not to be distracted by reflections in finding the direction from which a sound is coming. Psychoacoustic research has shown that a first reflection, which occurs shortly after the direct signal (within <25ms), must be stronger than the direct signal before it shifts the direction of the first arriving signal [11]. A second reflection from a different direction has to be even stronger than the first reflection to shift direction [12]. But later reflections (>30ms) draw increasingly more attention unless their amplitude decreases with longer delays. This makes sense because late reflections could actually be coming from a second source.

A loudspeaker in a room produces a large number of reflections and perceptual issues become difficult to study in detail because of the large number of signal streams that arrive at each ear of a listener, Figure 3, [13] Matters become even more complicated when the loudspeaker changes polar characteristics with emitted frequency; speaker L is typical for the vast majority of box loudspeakers. These speakers radiate omnidirectional at low frequencies and become increasingly more forward directional with higher frequencies while maintaining a flat on-axis response. Consequently such box loudspeaker illuminates the room quite differently from a constant directivity dipole - for example speaker R. The dipole's reflections produce different superimposed sound streams at the ears of a listener even when they arrive from the same directions as those of a box loudspeaker in the dipole's location.

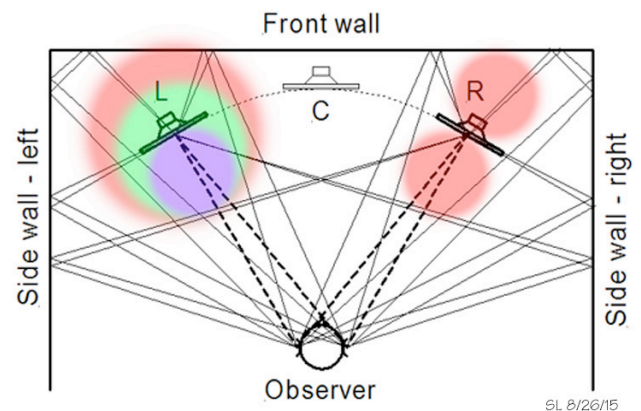

Figure 3: Direct signals and some of the reflections at the listener's ears for two types of loudspeakers: Dipole R with frequency independent radiation pattern and typical box loudspeaker L, which radiates omnidirectional at low frequencies and becomes increasingly forward directional with increasing frequency.

Sound from a loudspeaker near the corner of floor and two walls produces at least 7 reflections, Figure 4, [13] Three of these are first order reflections, three are second order and one is of third order. In reality there would also be ceiling reflections and reflections from a speaker in the left room corner. The direct and reflected signals bounce around in the room building up the sound pressure level (SPL) of the reverberant field

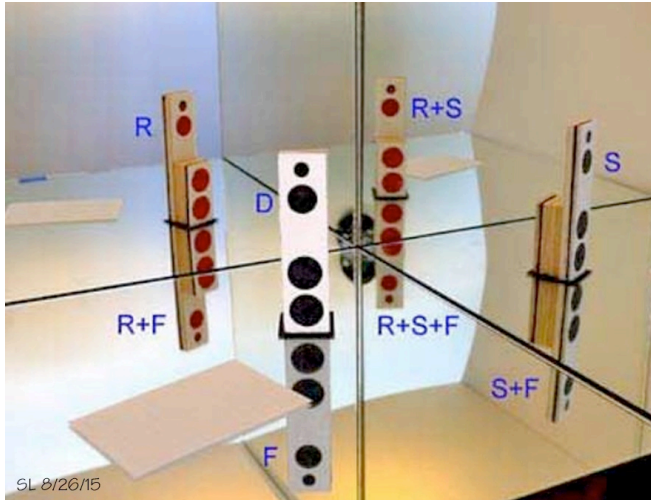

Figure 4: A dipole loudspeaker D near the corner of three intersecting surfaces and its images behind the perfectly reflecting surfaces. The images define the direction and the path length of the reflection. In combination with the polar diagram of the loudspeaker and the absorptive/diffusive characteristics of the surfaces the images also define the attenuation of the reflection at any point in front of the loudspeaker. First order reflections S, F, R, second order reflections S+F, R+F, R+S and third order reflection R+S+F.

and reaching a constant level nearly everywhere in the room if the source signal is sustained in SPL.

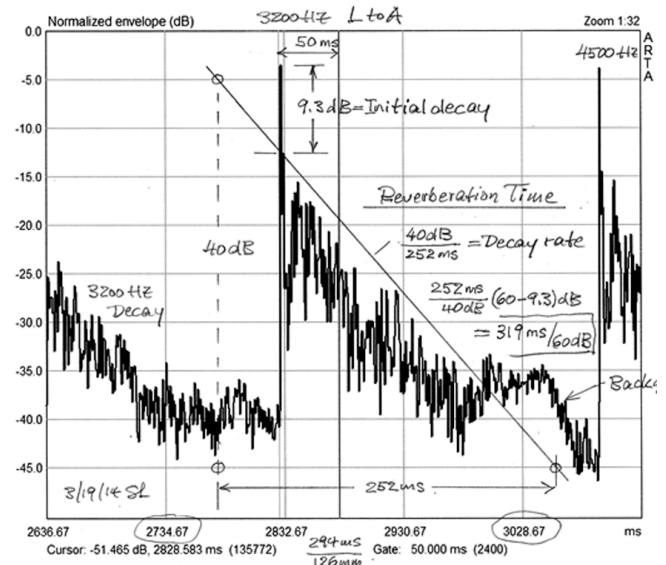

Figure 6: As Figure 5 but on expanded time scale to show more clearly the decay of the room reflections of the initial burst signal at the listening position. The 3200 Hz narrow band burst decays 60 dB in 319ms below the strongest initial reflection.

Figure 5 and Figure 6 are real world examples giving an indication of the complexities with which the ear-brain hearing apparatus has to deal in order to find the direction and distance of the physical source. Obviously, fewer or weaker reflections make the task easier. With stereo and two loudspeakers the listener's interest is not in the physical sources but the phantom sources and the auditory scene created by the direct loudspeaker signals. So the question becomes how to keep the reflections from becoming a distraction and how to move the room beyond the listener's acoustic horizon of attention.

2.2. Room Resonance Modes

Domestic listening rooms are acoustically small at low frequencies, where their largest dimensions are less than half of a wavelength. Sustained sounds will set up standing waves causing uneven distribution of SPL in the room, Figure 7, [14, 15]. The position of a loudspeaker in the room, its low frequency radiation pattern, and the sound absorptive characteristics of the room determine the degree to which these resonant modes are excited. Whether the source radiates omnidirectional, like a dipole or a cardioid, the longitudinal mode in Figure 7 will be set up. Only if the whole rear wall is totally absorptive or behaves like an open window will there be no standing wave. This is because there is no reflection back to the front wall. Standing

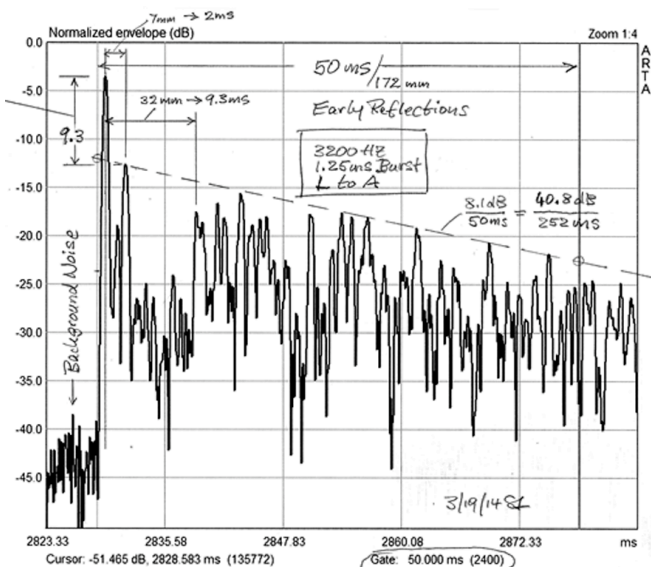

Figure 5: Example of a 1.25ms burst signal and its room reflections as they arrive at the listening position during the first 50ms. The burst amplitudes are progressively attenuated vs. time as the signal has traveled greater distances and hit multiple surfaces.

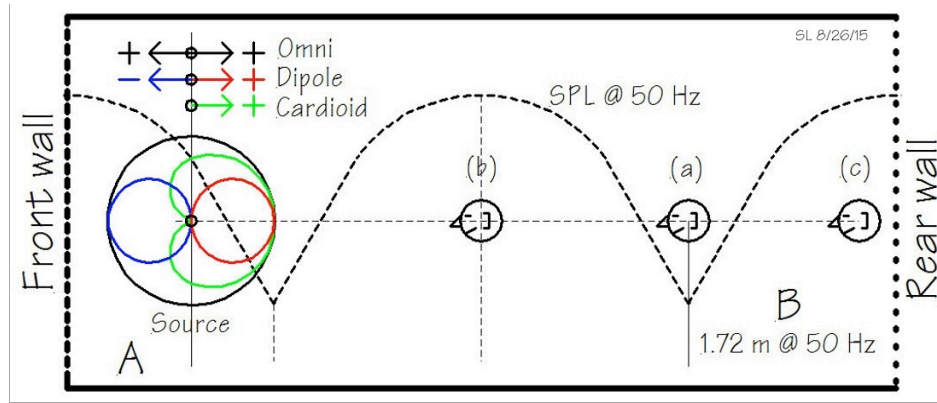

Figure 7: Standing wave (room resonance, longitudinal mode) example for a room of 6.88m length. For a continuous 50 Hz tone listener (a) sits at a SPL minimum, which occurs at 1/4-wavelength from the rear wall. Listener (b) sits at a SPL maximum, but at 25 Hz he would sit in a minimum. Listener (c) against the rear wall is in the maximum SPL region for all room modes.

waves are often problematic, particularly for a loudspeaker, which radiates more energy at low frequencies into the room than at higher frequencies like box speaker L in Figure 3. For a loudspeaker which is directional even at low frequencies - like the dipole R in Figure 3 or a cardioid loudspeaker - the coupling to offending modes can be changed by turning the speaker some amount.

Furthermore if the loudspeaker maintains the same polar pattern over the whole frequency range, then energy distribution from low to high frequencies in the room is only a function of the room's absorptive characteristics. Thus, bass from dipole loudspeakers is reproduced with greater articulation and more evenness at different listening room locations than from box speakers [16]. Articulation means that the envelope modulation of a bass signal is better preserved for different locations in the room. Any recorded ambiance from the recording venue will be

heard more clearly because the listening room is illuminated neutrally.

2.3. Reverberated Sound Field

If domestic rooms were simple rectangular boxes with known sound absorption coefficients for their boundary surfaces and without furniture in them, then it would be possible to predict the large number of modes that could be excited by a loudspeaker, Table 1, [14]. The number of modes 'N' increases with frequency as does the number of reflections since it takes two or more boundaries to set up a mode. In the example a) of a room with proportions deemed to have acceptable maxima and minima mode spatial distribution b), there could be up to 55 modes excited by the loudspeaker below $f_m = 150$ Hz depending upon its placement in the room and its radiation pattern below 'fm', c). In general, as frequency increases the average frequency separation of modes 'df' decreases, being down to 1.6

Table 1: Acoustic Properties c) and e) of an Unfurnished Rectangular Room with Dimensions a) and Estimated Wall Surface Absorption d)

a) Room dimensions L = 22.6 ft 6.88 m W = 16.0 ft 4.88 m H = 9.0 ft 2.75 m	Floor area A = 361 ft ² 33.6 m ² Volume V = 3253 ft ³ 92 m ³ Surface area S = 1417 ft ² 132 m ² Edge length Le = 190 ft 58 m	b) Acceptable room if: $1.1*(W/H) < (L/H) < 4.5*(W/H)-4$ 2.0 2.5 4.0 (R. Walker, BBC, 1996)
c) Below frequency fm = 150 Hz Total number of modes N = 55 Avg. mode spacing df = 1.6 Hz at fm	d) Estimated avg wall absorption a = 25% Reverberation time T60 = 456 ms	
e) Estimated reverberation time T60 = 456 ms Resonance bandwidth bw = 4.8 Hz Rise time Trise = 146 ms Schroeder frequency fs = 134 Hz Monopole reverb distance Rm = 0.80 m 2.6 ft Dipole reverb distance Rd = 1.39 m 4.6 ft Avg wall absorption a = 25%		SL 5/27/15

Hz at 'fm'. Each mode has a 3 dB bandwidth 'bw' and corresponding reverberation time 'T60', which is determined by the wall absorption properties 'a' at the frequency of excitation, Table 1d). A wall or surface absorption coefficient of 25% means that 1/4th of the room's surface area 'S' acts like an open window for sound to escape. That is a large equivalent area. It would have to be increased to 45% if a reverberation time of 250ms were targeted, which is only practically achieved for this size room by the addition of bulk absorbers and resonant absorbers. Such short reverberation times are useful for mixing studios with conventional box type monitors. But for domestic listening and the type of controlled directivity loudspeakers that are discussed later, they are not desirable [18]. The author has found a reverberation time around 450ms to be optimal for a normally furnished room with diffusive and absorptive elements.

Assuming a 456ms reverberation time the mode bandwidth 'bw' becomes 4.8 Hz, Table 1e). The bandwidth 'bw' is inverse proportional to 'T60' and is the same over the whole frequency range if the reverberation time is constant.

With increasing frequency the mode separation 'df' decreases; at the Schroeder frequency more than two modes fall within 'bw' [14]. The Schroeder frequency is roughly the boundary between the discrete standing wave modes below and the uniform, reverberated sound field above. For domestic size listening rooms 'fs' lies between 100 Hz for dead rooms and 200 Hz for fairly live rooms. The sound field above 'fs' takes on a uniform SPL distribution in the room for distances from the source, which are greater than the reverberation distance 'R', Table 1e). Direct and reverberant SPL are equal at 'R'. The reverberation distance is rather small but significant by indicating that a listener seated in the reverberant field would experience a higher direct-to-reverberant sound ratio (D/R) for the more directional source, i.e. 4.8 dB for the ratio of dipole 'Rd' compared to the monopole 'Rm' [18]. In other words a dipole source in a room with 450ms reverberation time is equivalent in terms of D/R to a monopole in a room with 150ms reverberation time.

The modes below 'fs' and the reverberated sound field above 'fs' build up with $Trise = 0.32 T60$ when sustained acoustic energy is supplied to the room [15]. It should be noted that 'Trise' is large compared to the duration of high frequency transients, meaning how well transients are heard at different locations in the room depends primarily on the dispersion of the direct sound from the loudspeaker and its reflections.

3. MAGIC IN STEREO

3.1. Typical Stereo Reproduction

Domestic listening rooms come in all shapes and sizes and rarely follow the simple model in Table 1. Except for a few of the lowest order modes and primary reflection areas, it becomes exceedingly difficult to make predictions about any room's potential acoustic behavior. Reverberation time is best measured and gives a general description for different frequency bands. How useful that is depends upon the loudspeakers that will be installed. The author even claims that the room's response to the loudspeaker is much less of a problem than how the loudspeaker illuminates the room.

How a loudspeaker will illuminate the room can in most cases be predicted by visual inspection of its shape, its physical dimensions, driver sizes and layout, which all help determine acoustic dimensions and diffraction effects. The vast majority of loudspeakers are constructed as rectangular boxes of various sizes, with narrow and tall front baffles, vertically aligned drivers and a vent either in front or in back [17]. The tweeter and the design axis are positioned at seated ear height, Figure 8. There are variations to the front baffle design with rounded edges, a narrower baffle for the tweeter or staggered baffles for "time alignment" of the drivers. The drivers themselves may be vertically aligned as T-W, T-M-W, M-T-M-W or various other configurations including coaxial T-M and W-W on opposing side panels. Regardless, all of these arrangements lead essentially to a horizontal polar pattern as for L in Figure 3 and to a vertical polar pattern that may exhibit lobing determined by the acoustic spacing of drivers and the crossover types used.

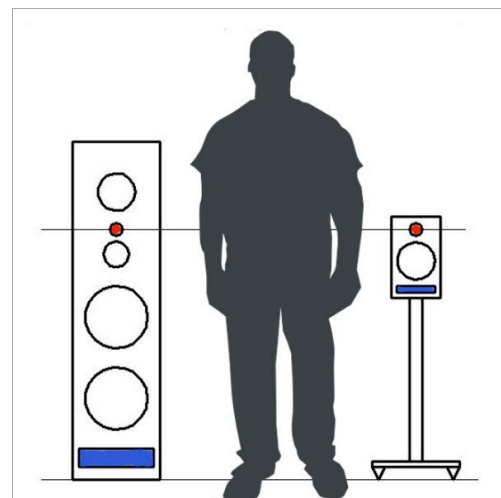

Figure 8: Generic box loudspeakers of various sizes and driver arrangements.

The 4π or "power response" of such speakers always starts out as being omni-directional at low frequencies where its dimensions are acoustically small compared to the radiated wavelength. At the high end the power response ends up to be 10 dB to 15 dB down because any practical tweeter becomes acoustically large and radiates primarily in forward direction regardless of the baffle size. The smoothness with which the power response decreases from low to high frequency has been found to be a strong contributor to perceived sound quality under reverberant conditions. But many loudspeakers seem to have been designed primarily for a flat or slightly down-sloping on-axis response, and sometimes averaged over a specified listening window, Figure 9 [11].

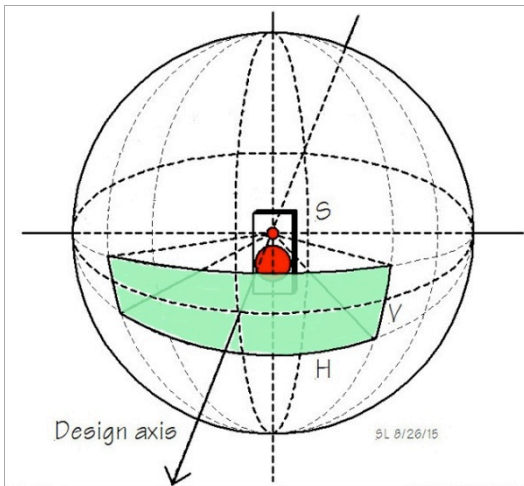

Figure 9: Loudspeakers radiate in all directions to varying degree, but are usually designed and measured for flat on-axis frequency response on a window around the design axis.

No wonder there is a generic loudspeaker sound. When two of such box loudspeakers are placed in a domestic listening room with all its variations or even when placed in an "acoustically designed" and treated room there emerges a fairly consistent pattern for rendering stereo recordings, Figure 10.

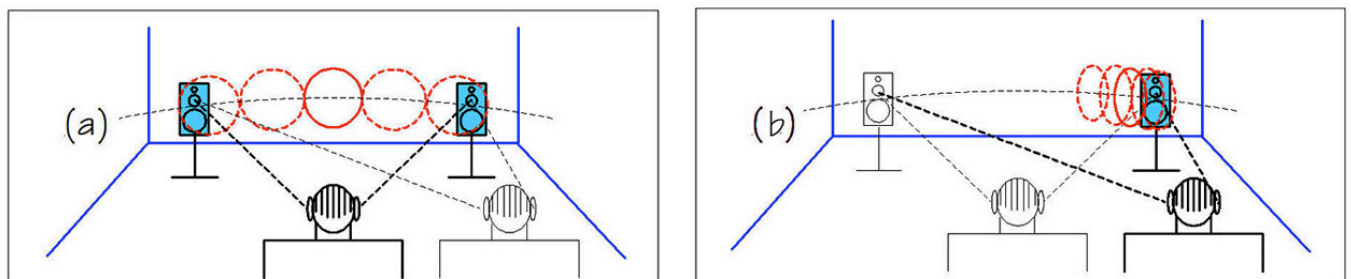

Figure 10: Typical stereo reproduction as heard from the "sweet spot" (a) and from off-center (b).

Assuming that the loudspeakers are set up symmetrical with respect to the side walls and not against the front wall and that the listener sits at the "sweet spot" - the apex of an equilateral triangle formed by speakers and listener - a phantom acoustic scene is perceived between the two loud speakers (a). The auditory scene (red) is created in the listener's mind based upon the direct sounds coming from the loudspeakers and the reflected and reverberated sounds in the room (blue). The more directional the speaker radiation the more spatially defined the phantom scene becomes horizontally. It should be called '*headphones from a distance*'. The loudspeakers are clearly perceived as hard boundaries of the scene. There is a distinct awareness of loudspeakers, room and scene (red and blue). The sonic signature of the loudspeaker not being neutral is more to blame for this behavior than the room.

A small lateral shift from the sweet spot shifts the whole auditory scene in the direction of the shift and for a listener off to the side the scene essentially collapses into the near loudspeaker. Little is heard from the other speaker. For highly directional speakers this effect can be reduced to some extent by toe-in.

3.2. Optimal Stereo Reproduction

The magic occurs when the loudspeakers seemingly disappear from the sound scene, to the point where the listener is inclined to ask: "What are these two contraptions in front of me doing?", Figure 11. All that is perceived is a phantom scene. A scene, which is not hard bounded by loudspeakers, softly windowed and extends behind and above the speakers. While there is a sweet spot, namely the apex of an equilateral triangle, the scene does not collapse into the nearest speaker upon moving to one side, but stays between the speakers with a perspective similar to what is heard at a concert when sitting to the side.

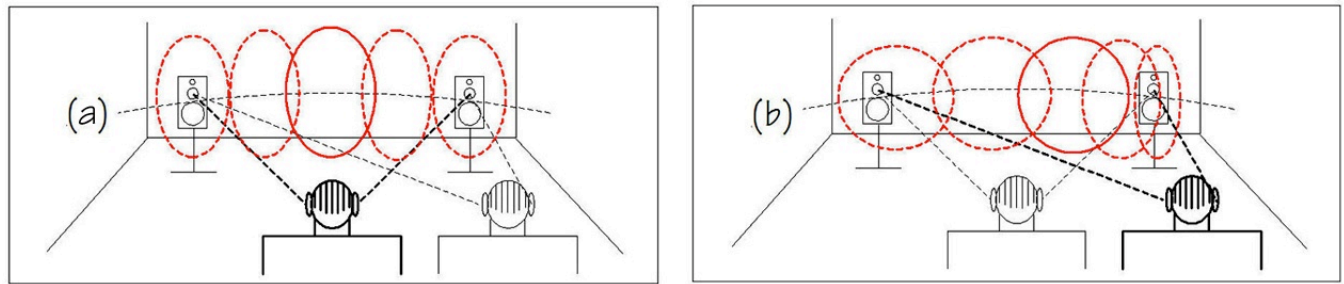

Figure 11: Optimal stereo reproduction as heard from the "sweet spot" (a) and from off-center (b).

Also, when farther away from the speakers and deep into the reverberant field in the listening room, the tonality does not change. The room is easily forgotten.

The magic is difficult to describe in pictures or words but is recognized within 30 seconds when heard. It usually elicits a big smile or even laughter from the listener. Naive listeners, audiophiles and professionals alike recognize the naturalness of presentation. On many recordings it is 3D in front of the listener and resembles a concert experience. When watching movies on a screen between the speakers, on-screen dialogue and sounds are clearly separated from those off-screen. Center and side speakers are not missed as the two speakers alone render a smooth continuum.

3.2.1. Loudspeaker and Setup Requirements

For the magic to occur there are five requirements, which I have been found to be essential:

1. The off-axis frequency response of the loudspeaker in the horizontal plane must mimic the on-axis response. The vertical polar response is not as critical but the formation of lobes should be avoided, i.e. the loudspeaker should be acoustically small. Such a loudspeaker has a neutral signature and its reflections and the reverberated sound field will have the spectral signature of the listening room. The polar pattern could be omni-directional, cardioid or dipolar with frequency independent power response. The omni pattern would produce the strongest interaction with the room and be the least desirable of the three.
2. The loudspeakers must be free of resonant radiation such as coming from vents or panels. Non-linear distortion must be low enough not to identify the speaker location during loud music passages. This demands adequate excursion and air volume displacement capability of woofers and tweeters.

3. The loudspeakers must be set up at least 1m distant from left and right side walls and 1m from the wall behind them. The resulting time delay of about 6ms is necessary for the ear-brain perceptual apparatus to separate direct from reflected sound streams. With neutral excitation of the room response, the listener can then withdraw attention from the room and process primarily the direct sound streams from the loudspeakers. This is similar to not hearing the ticking clock or to the cocktail party effect where attention and hearing is drawn to information streams of interest. Everything else is moved beyond the acoustic horizon as in survival mode.
4. The wall behind the loudspeakers is preferably diffusive and the wall behind the listener absorptive. The sound waves from the loudspeaker should be allowed to travel freely past the listener and not be reflected from a wall behind.
5. The listening room should have a reverberation time around 450ms, i.e. be neither acoustically dead nor overly live but comfortable for conversation and entertainment. If anything it should err in the direction of liveliness.

4. LOUSPEAKER DESIGN EXAMPLES

Loudspeakers that fulfill to varying degree requirements 1) and 2) have been available for a long time [17]. In the dipole family there are the physically and acoustically large panel radiators, for instance from KLH, Sound Lab, Martin Logan or Quad. The Quad ESL63 inspired the author to find a design that did not suffer from beaming, had extended bass, and was capable of reproducing large dynamics while still preserving the desirable characteristics of the Quad. Omni-directional loudspeakers are exemplified by Ohm, Walsh, Bose, German Physiks and MBL; cardioid speakers are available from Gradient, MEG or Kii.

Highly directional and efficient speakers were built by Klipsch. The overwhelming mass of loudspeakers sold, though, remains in the box paradigm.

The author's loudspeaker designs are first and foremost for use in his own living spaces. Thus he worked only under self-imposed constraints in terms of cost, size and aesthetics. A loudspeaker is to him not a piece of furniture but a transducer. As such it has an electrical input and produces an acoustic sound-field as output. Not selling loudspeakers but offering construction plans for DIY duplication. He likes to share what has given him satisfaction and enjoyment. Hopefully the work will have some influence on commercial products.

Here then are two recent examples, LX521.4 and LXmini, which, from the start, were designed with polar pattern and output capability that would be useful in a wide range of domestic room sizes and also capable of the magic mentioned above [18, 19]. The first is a full-range dipole, the second a mix of omni, cardioid, dipole and forward firing radiation Figure 12.

4.1. Dipole Loudspeaker Design Approach

Having clear objectives of where the speakers are to be used and what is to be accomplished, approach to loudspeaker design involves the following steps. Usually some of the steps have to be iterated to arrive at a solution that is satisfactory.

- a. First is driver selection for volume displacement capability at low distortion, and small acoustic size for the intended frequency range of use.
- b. Next an educated guess has to be made as to the baffle size and shape, which might provide acceptable dipole behavior over as wide a frequency range as possible for each driver.
- c. A prototype baffle is built and the polar response is measured in the frontal hemisphere under free-field conditions.
- d. The prototype baffle is modified until an acceptable dipole range is found for each driver.
- e. Each driver is equalized for flat on-design-axis frequency response and equal output level.
- f. The overlap in dipole behavior with the driver below and above in frequency and its volume displacement capability defines the electrical crossover frequency and filter order.
- g. With crossovers and equalization active the polarity of adjacent drivers is reversed and the relative electrical signal phase shift or delay are determined in order to obtain maximum acoustic cancellation at the set measurement point on the design axis.



(Left) LX521.4, a 4-way, full-range (20 Hz to 20 kHz) dipole consisting of three building blocks:

1. An open baffle woofer cabinet with two 10 inch drivers in push-pull arrangement to reduce even-order distortion,
2. A bridge over the woofer cabinet to isolate the open baffle on top from woofer cabinet vibration,
3. A top baffle with 8 inch lower midrange, 3 inch upper midrange drivers, and front and rear side 1 inch tweeters.

Electrical crossovers are at 120 Hz (LR4), 1 kHz (LR2) and 7.5 kHz (LR4). [18]

(Right) LXmini, a 2-way (45 Hz to 20 kHz) hybrid polar pattern loudspeaker speaker build up from:

1. An upward firing 5 inch driver in a sealed pipe
2. A forward firing 3 inch full-range driver without baffle and with a scattering body behind it.

Electrical crossover is at 750 Hz (LR2). [19]

Figure 12:

- h. When satisfied with free-field measurements a single speaker is listened to in monaural in the intended listening room. Free-field measurements are repeated if something seems wrong.
- i. A second speaker is built and listened to in stereo in the listening room. The woofer level is adjusted if necessary. Free-field measurements are repeated if something seems wrong.

Due to the acoustic short circuit between front and rear radiation of drivers on an open baffle it becomes especially important to find a woofer driver which is capable of large excursions without non-linear jumping effects and without air turbulence noise, Figure 13.



Figure 13: Rear side of open-baffle loudspeaker. Sound radiated to the rear is of opposite polarity to sound radiated from the front. The baffle contour and depth defines the path length and thus the amount of phase shift and the degree to which the rear radiation will cancel the sound in the frontal hemisphere.

4.1.1. Dipole Woofer

The woofer's (2 x 10" drivers) frequency response was measured with the microphone tip in the center of the opening plane of the woofer's V-frame baffle, Figure 14. The baffle sat on the ground to account for half-space operation. The response exhibits a peak at 250 Hz, which is the result of a $\lambda/4$ cavity-length resonance caused by the acoustic wave impedance mismatch at the baffle opening. The peak is easily equalized. If measured at a large distance, where front

and rear radiation from the baffle combine, the woofer's response would decrease at 6 dB/octave rate. Thus to obtain an identical dipole response, as the one measured in the opening plane, it is necessary to add equalization, which boosts lower frequencies at 6 dB/octave rate. Additional equalization can turn the dipole response flat to a target corner. The woofer is crossed over at 120 Hz to a lower midrange driver and operates only in a range where it is acoustically small.

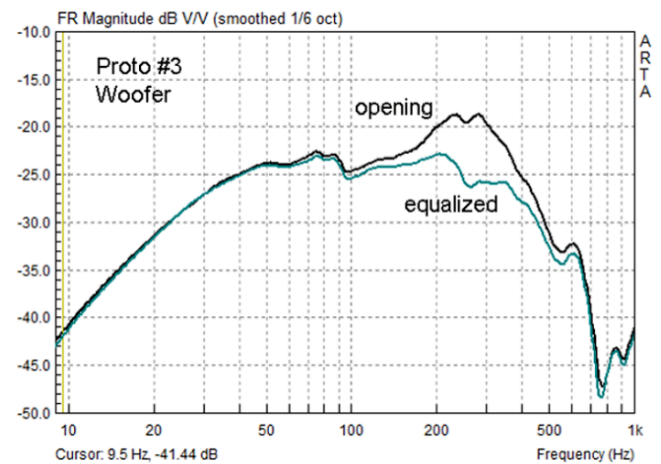

Figure 14: Woofer output before dipole equalization. The V-frame cabinet resonance must also be equalized.

4.1.2. Dipolar Lower Midrange

The polar response of the top baffle was measured from 0.5m distance in the backyard, being elevated and positioned on a manual turntable. The lower midrange 8" driver exhibits close to textbook behavior up to about 1kHz, Figure 15. The baffle shape was determined empirically. Only frontal radiation was measured. Rear

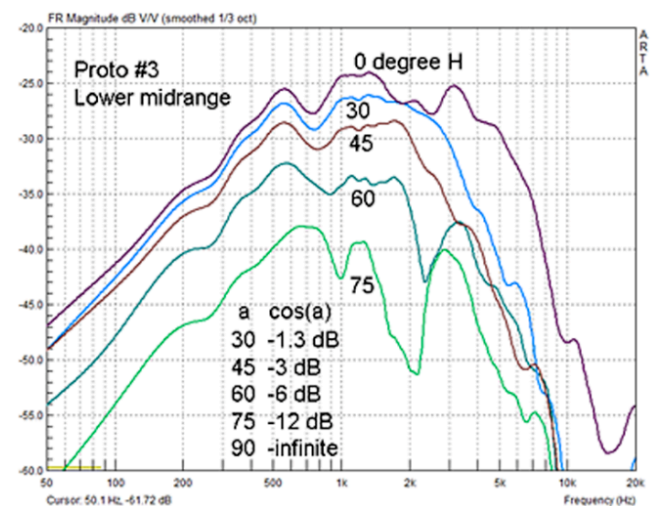

Figure 15: Lower midrange driver (8") in its optimized baffle section.

radiation reaches the listener *via* room reflections and reverberation, which makes the details of the response much less important. The total power radiated to the rear is assumed to be similar to the total power radiated to the front hemisphere.

4.1.3. Dipolar Upper Midrange

The upper midrange driver with its narrow baffle is well behaved above 1kHz, Figure 16. The response widens between 0° and 30° around 3.5kHz but is in general quite useable up to 10kHz. When the upper and lower midrange drivers are combined with a LR2 crossover at 1kHz, i.e. a crossover that is 6 dB down at 1kHz and provides in-phase addition, then the resulting overall response indicates dipolar behavior over a very wide frequency range. In general, it would take many sets of measurements to fully describe the polar radiation in detail when the baffle dimensions and vertical distances between drivers are no longer acoustically small.

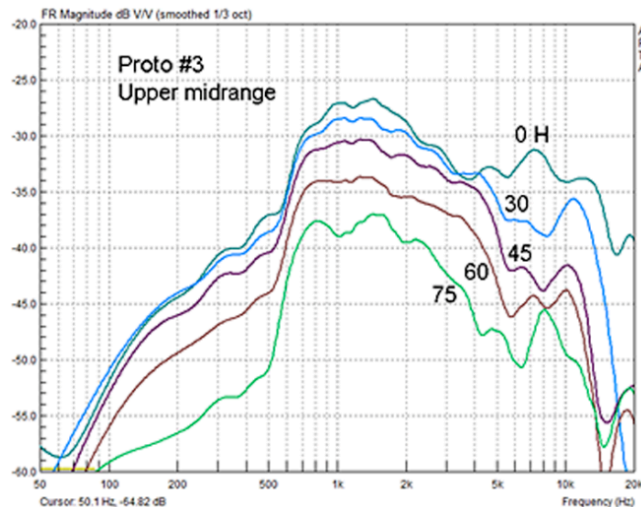

Figure 16: Upper midrange driver (3") in its optimized baffle section.

4.1.4. Dipolar Tweeters

Radiation from front and rear tweeters interacts in space forming a radiation pattern with sound cancellation in the plane of the baffle and a dipole-like angular dependency, Figure 17. Below 2kHz the baffle is acoustically small and a true dipole response results. Above 5kHz the inherent directivity of the dome drivers takes over. Front and rear radiation only interact at large off-axis angles. An LR4 crossover at 7.5kHz was chosen to combine the tweeters with lower and upper midranges.

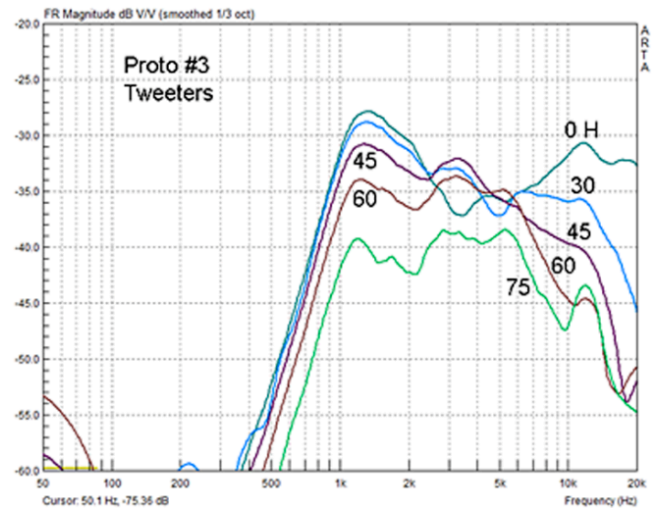

Figure 17: Tweeter drivers (2 x 1") in their optimized baffle section.

4.1.5. Equalization and Crossovers

Except for the tweeter, extensive equalization is required for the other drivers to obtain an acoustically flat on-axis response, Figure 18. It would be impractical to do this with passive, high level networks, though it could be accomplished with opamp circuitry. The easiest way today is to implement the filters in DSP and to use individual power amplifiers for each driver.

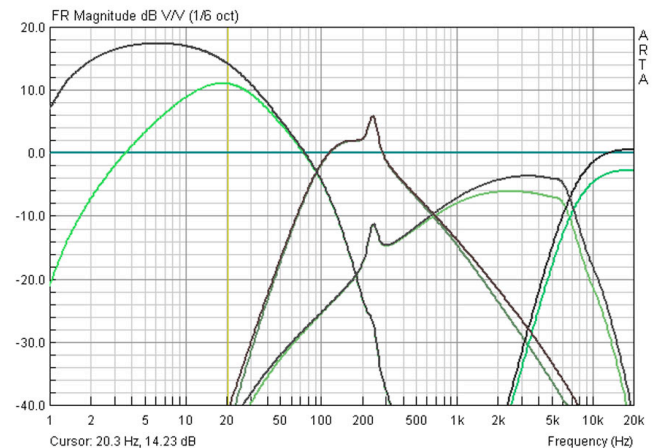

Figure 18: Equalization and crossover frequency response as generated by DSP.

4.1.6. Response in Horizontal and Vertical Plane

Driver centers are vertically aligned along a 1m line. The loudspeaker's overall height is 1.25m. The vertical response around the design axis, which intersects the top panel between lower and upper midrange drivers, is typically only optimal over a +/-20° window at the top end of the frequency range under free-field conditions because distances between drivers are no longer

acoustically small. The wide, $\cos(\alpha)$ dispersion of individual drivers not only horizontally but also to a high degree vertically generates spectrally neutral reflections and reverberation. Thus moving about in the listening room does not change the tonality of sound. Only the preciseness of imaging changes as the direct-to-reverberant sound ratio decreases with distance. The minimum distance to the sweet spot is about 2.5m with the minimum room volume about 75m^3 to allow for space and breathing room around the loudspeakers.

4.2. Hybrid Loudspeaker

A physically small loudspeaker like the LXmini 2-way can have a well defined radiation pattern due to small baffle areas and driver layout, Figure 19. The upward pointing woofer driver (5 inch) at the end of a sealed pipe radiates omni-directional at low frequencies. The open baffle full-range driver (3 inch) above it radiates as a dipole. The combined output of the two drivers in the crossover frequency region takes on cardioid behavior. A cylindrical scattering body behind the dipole disperses the rear radiation to minimize specular reflections when the loudspeaker is set up close to a wall behind it. Bass and full-range sections of the loudspeaker are acoustically coincident. The combined source is at ear height for a seated listener and bass is not reinforced by the floor, but immediate surroundings will have some effect, if they are close - that is unavoidable.



Figure 19: Acoustically coincident layout of woofer and full-range drivers and with cylindrical scattering body behind the full-range.

The woofer's PVC pipe is stuffed with absorbing material. The sound wave traveling down inside the pipe is attenuated and reflected from the sealed end. It is attenuated further coming back up the pipe and

through the aluminum cone of the woofer driver so that it is about 40 dB below the radiation coming directly off the front of the cone. The pipe thus acts as an infinite acoustic transmission line with 40 dB return loss. A pipe also has extreme circumferential stiffness so that spurious radiation from its large surface area is completely insignificant. For the critical frequency range up to 1kHz where the open-baffle full-range driver takes over, the sealed pipe behaves quite differently from a sealed or vented box with its spurious panel vibrations.

The orthogonal arrangement of driver axes, which is unlike a coaxial driver arrangement, should minimize Doppler distortion. It has not been determined how much this contributes to the excellent sound from the LXmini. A pair of these speakers can be listened to as close as from 1m and is ideal as a near-field monitor or in a small room.

4.2.1 Radiation Pattern

The on-axis response extends from 45 Hz to 20kHz, Figure 20. The radiation pattern is essentially rotation symmetrical around the full-range driver axis. It can be seen that the loudspeaker becomes increasingly more directional above 1kHz in the frontal hemisphere as it transitions from omni-directional through cardioid to dipole radiation. The dipole then monotonically narrows dispersion due to 3" driver acoustic size, Figure 21.

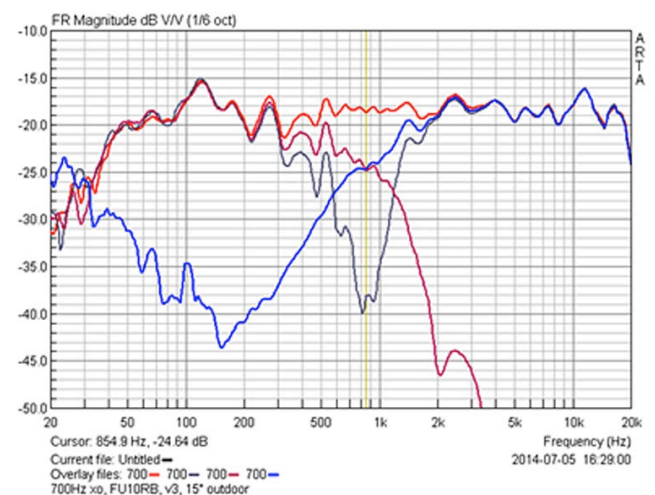

Figure 20: Equalized and crossed over frequency responses on full-range driver axis for individual drivers at 0.38m for normal and reversed polarity of the full-range driver. (Outdoor Measurement contaminated with reflections and low frequency noise).

In the rear hemisphere the radiation pattern goes from omni-directional at low frequencies through a

cardioid notch to more or less diffusive radiation above 2kHz due to the diffracting body which also adds some amount of attenuation, Figure 22. Overall the loudspeaker has a power response which falls with increasing frequency from 0 dB at the low end to -4.8 dB for cardioid and dipole regions and further due to the increasing directivity of the full-range driver. But unlike a box speaker it preserves much of the rear radiation for the reverberant sound field in the room, which leads to a more neutral tonality. Again, as with the LX521, moving about in the listening room does not change that tonality except when standing close to the LXmini or behind it. From the sweet spot both the LXmini and LX521 sound and image very much alike.

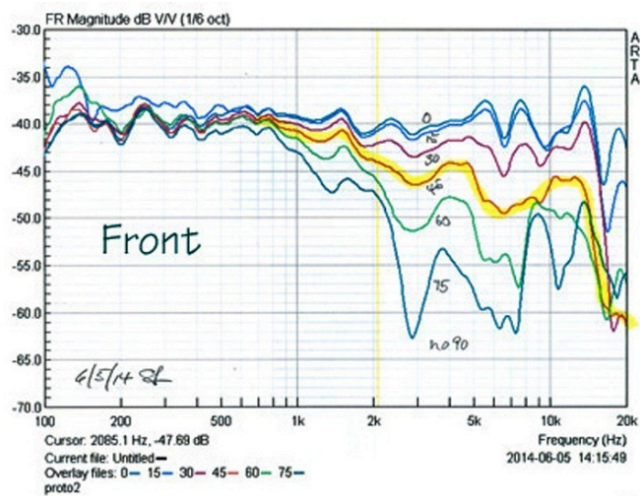

Figure 21: Radiation pattern in frontal hemisphere from 0° to 90° in 15° increments. (+/-45° in yellow) Measured in horizontal plane.

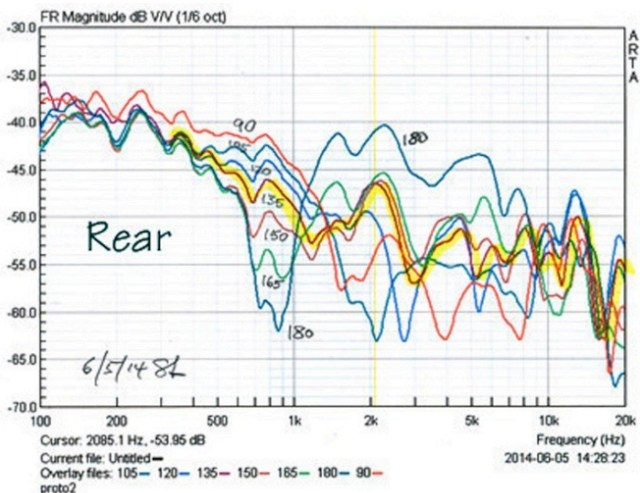

Figure 22: Radiation pattern in rear hemisphere from 0° to 90° in 15° increments. (+/-45° in yellow) Measured in horizontal plane.

4.2.2. Equalization and Crossover

The woofer driver requires minimal equalization to extend its response to 45 Hz. Below this frequency it rolls off at 12 dB/octave rate due to the sealed pipe enclosure. The frequency response shaping is accomplished most easily with a DSP unit having stereo inputs and four output channels. The full-range driver requires extensive equalization for a flat output response to 20kHz, Figure 23. The driver works in break-up mode over most of its frequency range. It would be difficult and costly to equalize it with passive or active analog circuitry.

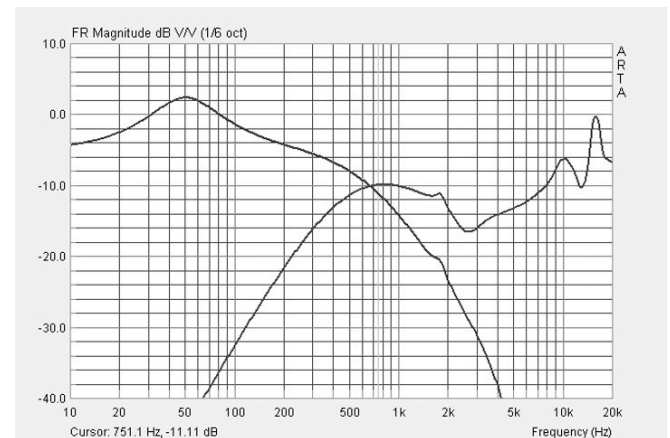

Figure 23: Woofer and full-range electrical drive levels as generated by DSP to obtain a flat on-axis acoustic frequency response. The curves combine individual driver equalization and 700 Hz LR2 crossover between woofer and full-range.

The electrical LR2 crossover between woofer and full-range drivers is set to 700 Hz. The 12 dB/octave filter slopes provide wide overlap between the two drivers in order to gradually and smoothly change the radiation pattern from omni-directional to dipolar while going through a cardioid frequency region. Each driver requires its own power amplifier of 50 W to 150 W output capability, i.e. 4-channels of amplification for a stereo setup.

The LXmini strikes a remarkable balance between acoustic performance, physical size, bass output and cost. The speaker is at home in any size domestic room. It is well capable of producing the magic which I have described above.

5. THE CHALLENGE

The loudspeaker industry has developed excellent electro-acoustic transducers/drivers over the last 50 years. But when put in boxes of various shapes and sizes in order to send a flat on-axis signal to the listener, illuminating the room neutrally without spurious

emissions from the baffle panels has resulted in progress that has been marginal at best.

Actually, the greatest weakness of today's speakers is their acoustic design. Exceptions are rare and their market share is small. Lack of progress must also be blamed on equipment reviewers for the various audiophile magazines when they act as gate keepers and are beholden to the magazine's advertisers.

If each manufacturer would build a pair of LXmini's as a reference for their product development in order to hear which way they exceed or miss the LXmini's performance, then real progress might be made. Also, each equipment reviewer should build a pair of LXmini's as a reference for comparing other speakers to; this would help to make obvious, in a perceptually meaningful way, the differences between sound systems as experienced in the reviewer's unique and visibly displayed setup and listening environment. Since it is not difficult nor costly for consumers to DIY build the LXmini as their own reference, they would then know what to expect from a reviewer's description of a different loudspeaker. The LXmini defines a standard of excellence that top of the line loudspeakers should meet or exceed before being promoted as superlative products.

REFERENCES

- [1] Bregman S. Auditory Scene Analysis - The Perceptual Organization of Sound. The MIT Press 1999.
- [2] Beranek LL and Mellow TJ. Acoustics - Sound Fields and Transducers. Elsevier Academic Press 2012.
- [3] Meyer J. Acoustics and the Performance of Music, Springer 2009.
<http://dx.doi.org/10.1007/978-0-387-09517-2>
- [4] Rumsey F. Spatial Audio, Focal Press 2005.
- [5] Wittek H. Image Assistant, JAVA applet for determining the, "Stereo Recording Angle", www.hauptmikrofon.de.
- [6] SCHOEPS Mikrofone. Showroom, www.schoeps.de/en/applications/showroom.
- [7] Rakert WM. Hartmann, "Localization of sound in rooms. V. Binaural coherence and human sensitivity to interaural time differences in noise". J Acoust Soc Am 2010; 128(5).
- [8] Linkwitz S. A Model for Rendering Stereo Signals in the ITD-Range of Hearing, 133rd AES Convention, San Francisco 2012, Preprint 8713.
- [9] Benjamin E. An experimental Verification of Localization in Two-Channel Stereo, 121st AES Convention, San Francisco 2006, Preprint 6968.
- [10] Blauert J. Spatial Hearing. The MIT Press 1997.
- [11] Toole FE. Sound Reproduction. Focal Press 2008.
- [12] Damaske P. Acoustics and Hearing. Springer 2008.
- [13] Linkwitz S. Room Reflections Misunderstood?. 123rd AES Convention. New York October 2007, Preprint 7162.
- [14] Kuttruff H. Room Acoustics. John Wiley and Sons 1973.
<http://dx.doi.org/10.4324/9780203186237>
- [15] <http://www.linkwitzlab.com/rooms.htm>
- [16] Linkwitz S. Investigation of Sound Quality Differences between Monopolar and Dipolar Woofers in Small Rooms. 105th AES Convention, San Francisco 1998 Preprint 4786.
- [17] The Absolute Sound's Illustrated History of High-End Audio. Volume 1: Loudspeakers, Edited by Robert Harley, Next screen, Austin, Texas, 2013.
- [18] <http://www.linkwitzlab.com/LX521/Description.htm>
- [19] <http://www.linkwitzlab.com/LXmini/Design.htm>

Received on 21-10-2015

Accepted on 15-12-2015

Published on 31-12-2015

DOI: <http://dx.doi.org/10.15377/2409-9821.2015.02.02.2>

© 2015 S. Linkwitz; Avanti Publishers.

This is an open access article licensed under the terms of the Creative Commons Attribution Non-Commercial License (<http://creativecommons.org/licenses/by-nc/3.0/>) which permits unrestricted, non-commercial use, distribution and reproduction in any medium, provided the work is properly cited.